

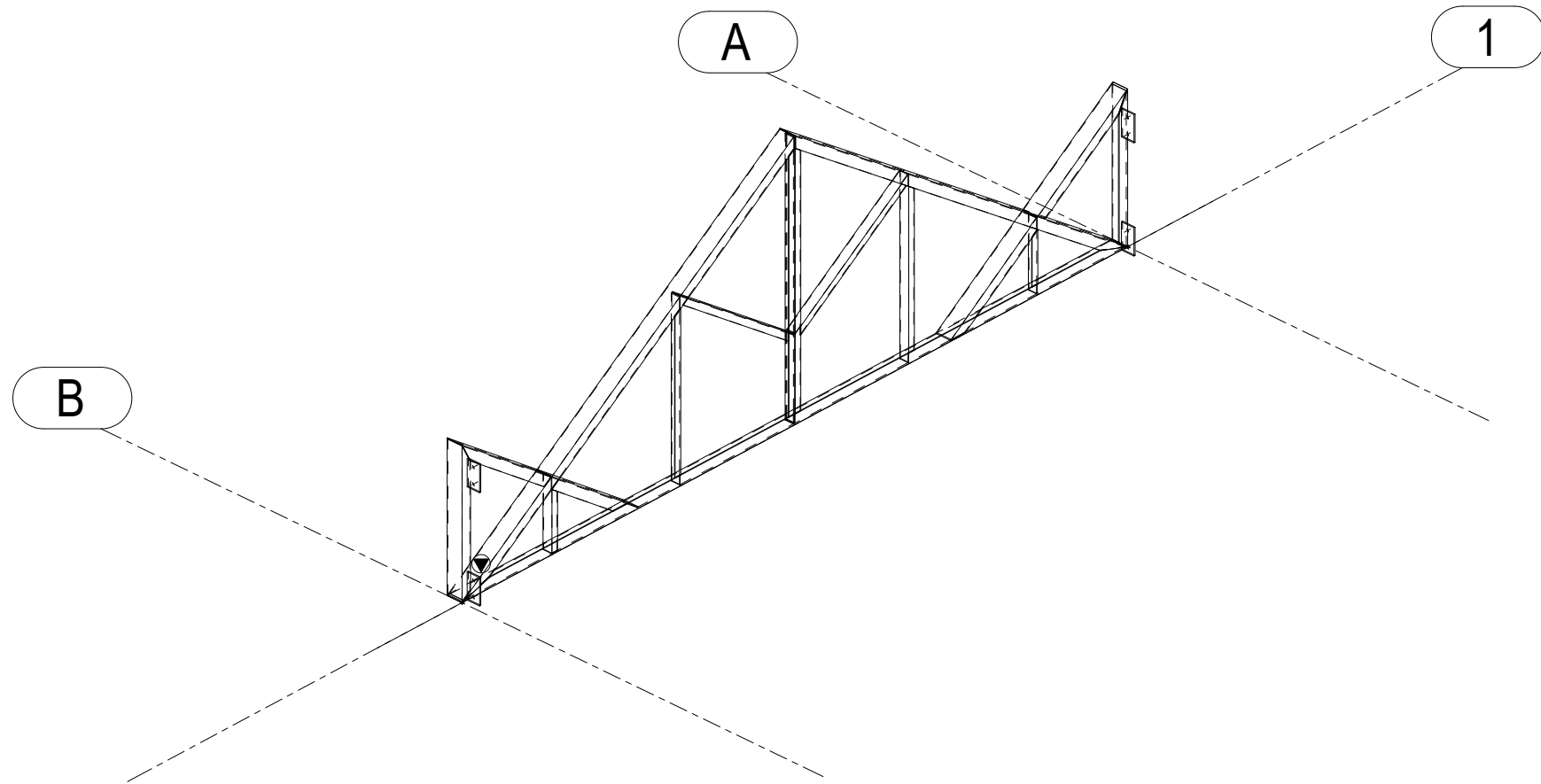

- Notes
- All dimensions mm
 - Debur and remove sharp edges.

BILL OF MATERIALS		ASSEMBLY MK'D :		TR-1		ASSY QTY : 1		
Item Mark	Qty / Assembly	Profile Size	Wt./Meter	Length	Wt./Item	Total Qty.	Total Wt.	Material
v5	1	ISA125X75X6	9.20	5890	54.10	1	54.10	IS2062
pl1	4	PLT10*105	78.50	200	1.65	4	6.59	IS2062
v1	1	ISA125X75X6	9.20	941	8.64	1	8.64	IS2062
v2	1	ISA125X75X6	9.20	939	8.62	1	8.62	IS2062
v3	1	ISA125X75X6	9.20	3585	32.93	1	32.93	IS2062
v4	1	ISA125X75X6	9.20	3585	32.93	1	32.93	IS2062
v6	1	ISA125X75X6	9.20	1115	10.24	1	10.24	IS2062
v7	1	ISA125X75X6	9.20	974	8.95	1	8.95	IS2062
v8	1	ISA125X75X6	9.20	1115	10.24	1	10.24	IS2062
v9	1	ISA125X75X6	9.20	974	8.95	1	8.95	IS2062
v10	1	ISA75X50X5	4.70	1331	6.29	1	6.29	IS2062
v11	1	ISA75X50X5	4.70	539	2.55	1	2.55	IS2062
v12	1	ISA75X50X5	4.70	539	2.55	1	2.55	IS2062
v13	1	ISA75X50X5	4.70	2030	9.59	1	9.59	IS2062
v14	1	ISA75X50X5	4.70	2030	9.59	1	9.59	IS2062
v15	1	ISA75X50X5	4.70	1330	6.29	1	6.29	IS2062
v16	1	ISA75X50X5	4.70	1221	5.77	1	5.77	IS2062
v17	1	ISA75X50X5	4.70	1223	5.78	1	5.78	IS2062
Total							230.59	



3D VIEW OF TRUSS

Material			Finish	Weight	Quantity
-					
Status			Referenced in assemblies		A3 Scale
Checked date	Engineering approved date	Fabrication approved date			
Drawn by PNM	Date 13/12/2019	Category			
3D VIEW OF TRUSS					
				Revision - 0	Sheet 1 OF 1

- Notes
 1. All dimensions mm
 2. Deburr and remove sharp edges.

BILL OF MATERIALS		ASSEMBLY MK'D : TR-1		ASSY QTY : 1				
Item Mark	Qty / Assembly	Profile Size	Wt./Meter	Length	Wt./Item	Total Qty.	Total Wt.	Material
v5	1	ISA125X75X6	9.20	5890	54.10	1	54.10	IS2062
pl1	4	PLT10*105	78.50	200	1.65	4	6.59	IS2062
v1	1	ISA125X75X6	9.20	941	8.64	1	8.64	IS2062
v2	1	ISA125X75X6	9.20	939	8.62	1	8.62	IS2062
v3	1	ISA125X75X6	9.20	3585	32.93	1	32.93	IS2062
v4	1	ISA125X75X6	9.20	3585	32.93	1	32.93	IS2062
v6	1	ISA125X75X6	9.20	1115	10.24	1	10.24	IS2062
v7	1	ISA125X75X6	9.20	974	8.95	1	8.95	IS2062
v8	1	ISA125X75X6	9.20	1115	10.24	1	10.24	IS2062
v9	1	ISA125X75X6	9.20	974	8.95	1	8.95	IS2062
v10	1	ISA75X50X5	4.70	1331	6.29	1	6.29	IS2062
v11	1	ISA75X50X5	4.70	539	2.55	1	2.55	IS2062
v12	1	ISA75X50X5	4.70	539	2.55	1	2.55	IS2062
v13	1	ISA75X50X5	4.70	2030	9.59	1	9.59	IS2062
v14	1	ISA75X50X5	4.70	2030	9.59	1	9.59	IS2062
v15	1	ISA75X50X5	4.70	1330	6.29	1	6.29	IS2062
v16	1	ISA75X50X5	4.70	1221	5.77	1	5.77	IS2062
v17	1	ISA75X50X5	4.70	1223	5.78	1	5.78	IS2062
Total							230.59	

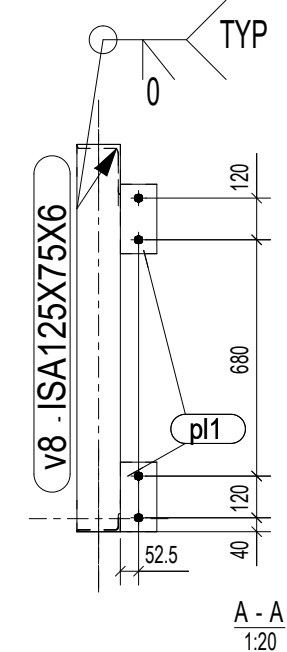
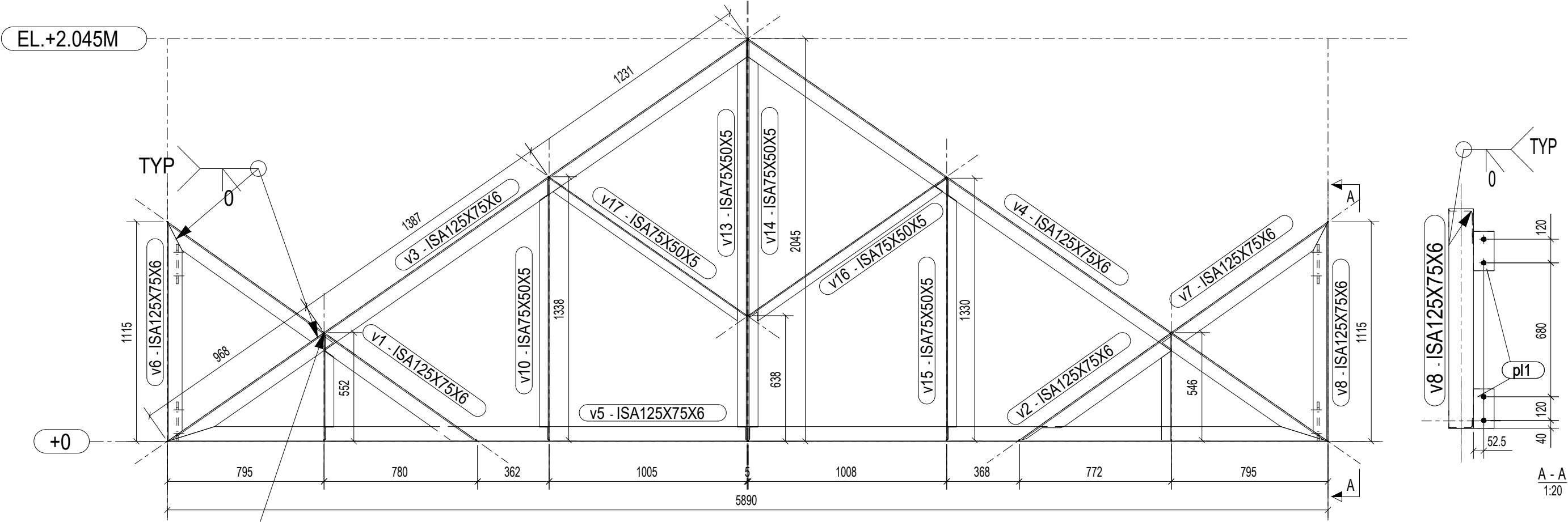
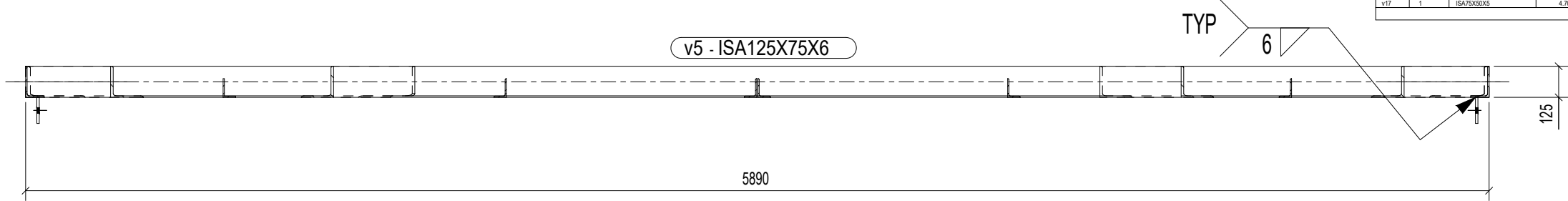

Material	Finish	Weight	Quantity
--			
Status	Referenced in assemblies		A3 Scale
Checked date	Engineering approved date	Fabrication approved date	
Drawn by PNM	Date 13/12/2019	Category	
GENERAL ARRANGEMENT OF TRUSS			
			Revision - 0
			Sheet 1 OF 2



- Notes
 1. All dimensions mm
 2. Deburr and remove sharp edges.

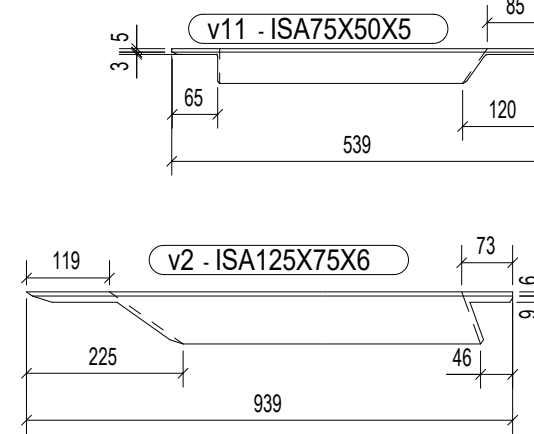
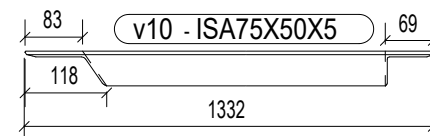
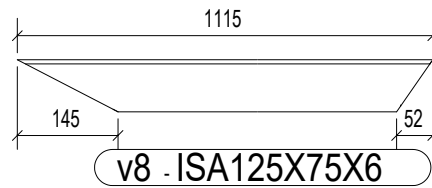
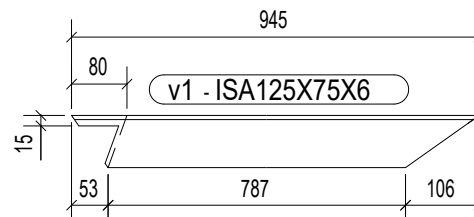
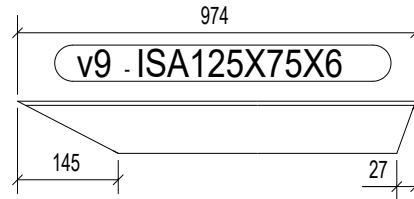
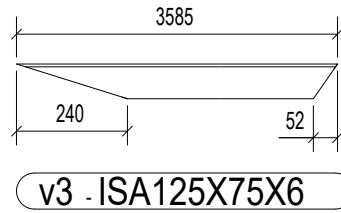
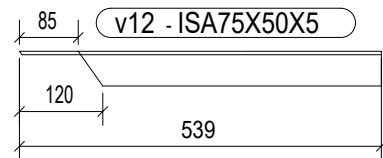
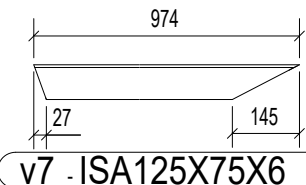
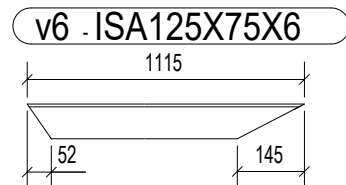
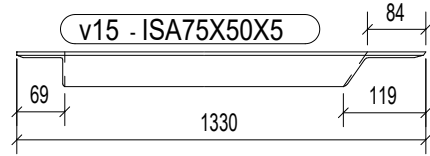
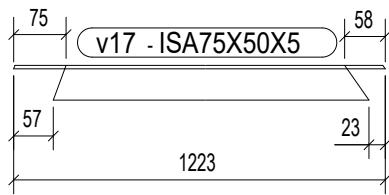
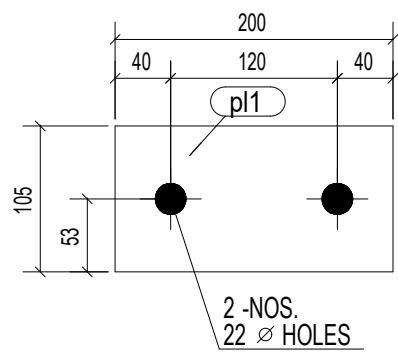
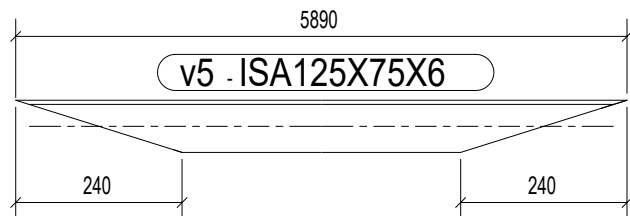
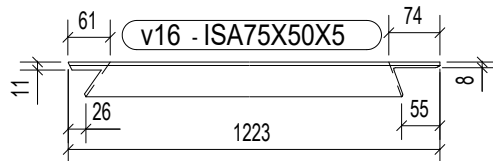
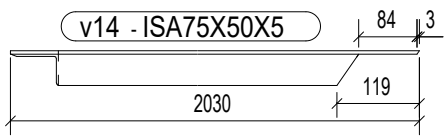
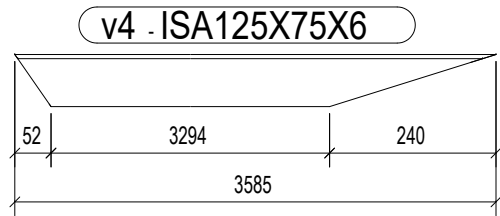
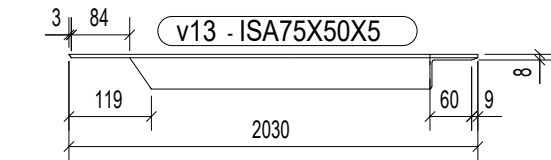

BILL OF MATERIALS		ASSEMBLY MKD : TR-1		ASSY QTY : 1				
Item Mark	Qty / Assembly	Profile Size	Wt./Meter	Length	Total Qty.	Total Wt.	Material	
v5	1	ISA125X75X6	9.20	5890	54.10	1	54.10	IS2062
pl1	4	PLT10*105	78.50	200	1.65	4	6.59	IS2062
v1	1	ISA125X75X6	9.20	941	8.64	1	8.64	IS2062
v2	1	ISA125X75X6	9.20	939	8.62	1	8.62	IS2062
v3	1	ISA125X75X6	9.20	3585	32.93	1	32.93	IS2062
v4	1	ISA125X75X6	9.20	3585	32.93	1	32.93	IS2062
v6	1	ISA125X75X6	9.20	1115	10.24	1	10.24	IS2062
v7	1	ISA125X75X6	9.20	974	8.95	1	8.95	IS2062
v8	1	ISA125X75X6	9.20	1115	10.24	1	10.24	IS2062
v9	1	ISA125X75X6	9.20	974	8.95	1	8.95	IS2062
v10	1	ISA75X50X5	4.70	1331	6.29	1	6.29	IS2062
v11	1	ISA75X50X5	4.70	539	2.55	1	2.55	IS2062
v12	1	ISA75X50X5	4.70	539	2.55	1	2.55	IS2062
v13	1	ISA75X50X5	4.70	2030	9.59	1	9.59	IS2062
v14	1	ISA75X50X5	4.70	2030	9.59	1	9.59	IS2062
v15	1	ISA75X50X5	4.70	1330	6.29	1	6.29	IS2062
v16	1	ISA75X50X5	4.70	1221	5.77	1	5.77	IS2062
v17	1	ISA75X50X5	4.70	1223	5.78	1	5.78	IS2062
Total						230.59		

Material	Finish	Weight	Quantity
--			
Status	Referenced in assemblies		A3 Scale
Checked date	Engineering approved date	Fabrication approved date	
Drawn by PNM	Date 13/12/2019	Category	
PART DETAILS OF TRUSS			
Revision - 0			Sheet 2 OF 2

